

Motorized test stand MX2 series MX2-500N/1000N/2500N/5000N

- Achieves high repeatability with constant testing speed and position
- Easy digital setting of testing modes and speed
- Offers useful functions operated together with force gauge

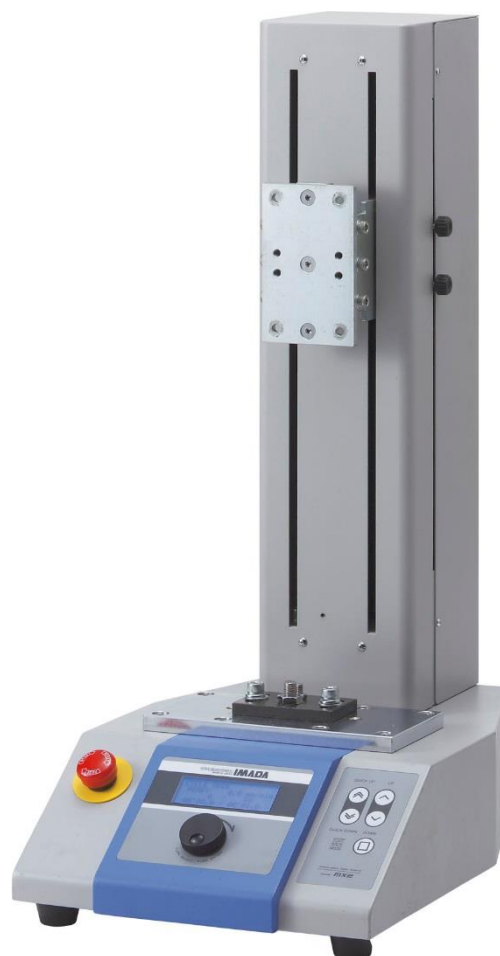

MX2-500N



MX2-2500N

Features

Improved Repeatability

- Constant testing speed and position for applying compression and tensile force
- Rugged design minimizes influence of deformation (max.0.5mm)

Easy Operation

- Ergonomically inclined control panel
- Dial operation for digital setting
- Three testing modes to meet testing requirements

Versatility for a wide variety of testing

- Ideal for durability test by setting the number of test cycles to repeat
- Useful timer function for compression testing allows pausing at a set force value. (*)
- Attached table can mount a wide range of grips and fixtures.
- Optional functions for various purposes

Functions for efficient testing

- Easy setting of travel distance depending on the sample height.
- Automatically changes traveling and measuring speed at a set force value. (*)
- Starts software together with test stand motion.(*)

* Requires certain models of force gauge and optional cable.

[Application Example and Configurations]

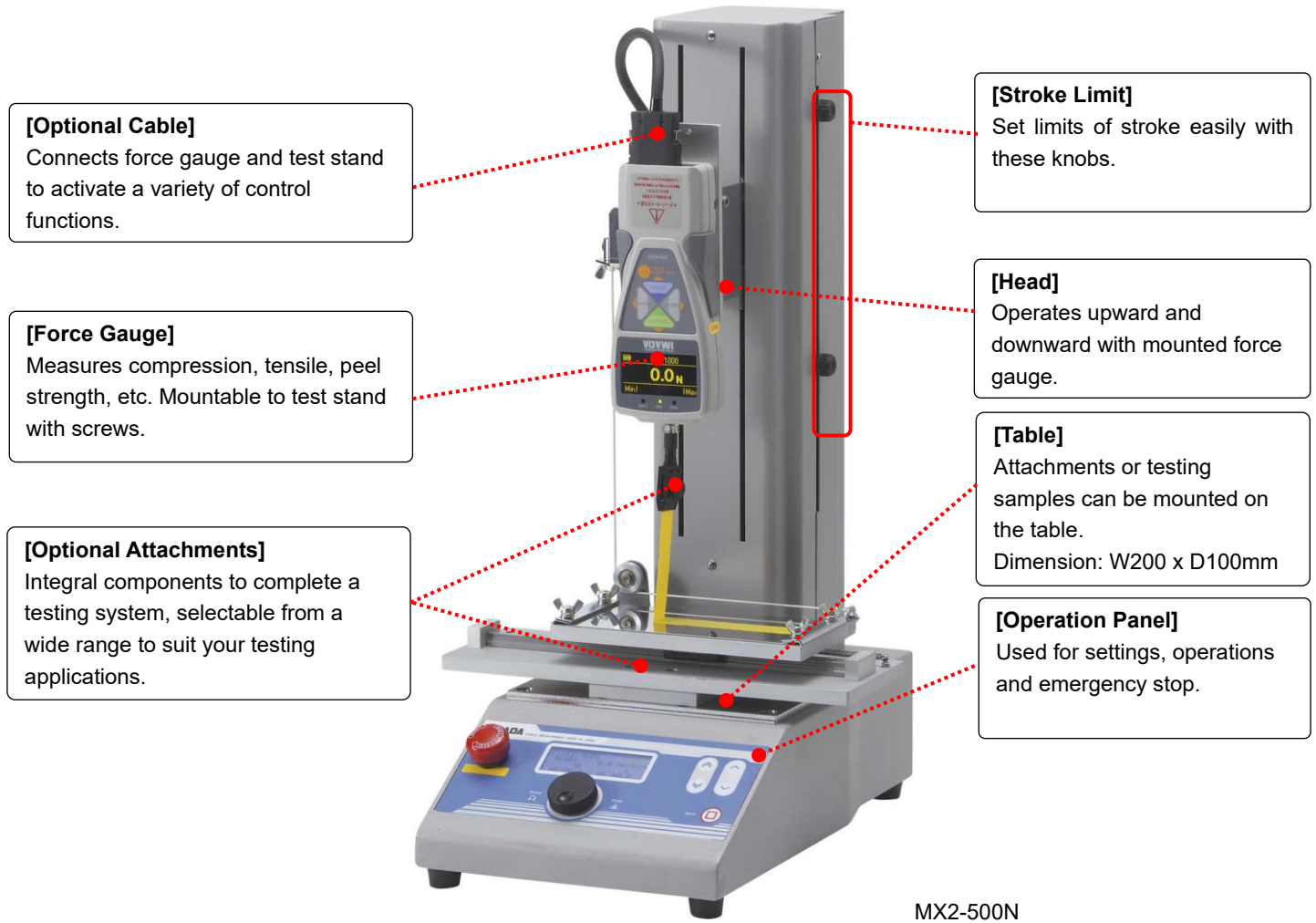

MX2-500N



*Force gauge, optional attachments and optional cable are sold separately.

[Operation Panel]



MX2-500N display



[Applications] Use suitable attachments to perform a variety of measurements.

Wire crimp pull test	Peel test of tapes	3-point bend material testing
Tests the strength of crimped terminal by measuring the tensile force required to remove a crimped terminal.	Tests adhesive strength by peeling off the adhesive tape affixed on the table.	Applies compression force to test strength of materials such as metal by bending or breaking.
		

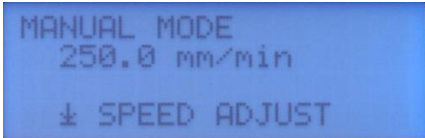
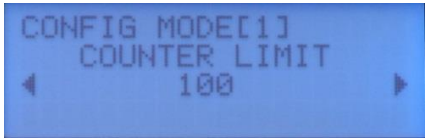
[Basic Operations]



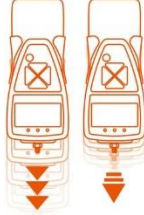

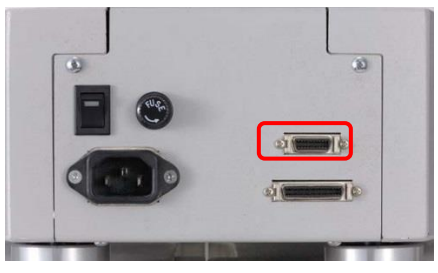
<p>Adjusting speed</p>		<p>Testing speed is easily adjustable with dial.</p> <p>Setting resolution: [10-20mm/min: 0.5mm/min] [20-100mm/min: 5mm/min] [100-300mm/min: 10mm/min]</p> <p>Adjustable speed types: Start, Measuring, Return</p>
<p>Three measuring modes</p>		<p>Three testing modes are available to meet requirements.</p> <ul style="list-style-type: none"> • Manual mode: Moves while up/down buttons are pressed. • JOG mode: Minute feeding by turning dial (approx. 0.05mm per 1 turn) • Cycle mode: Travels between stroke limit knobs for cycles.
<p>Other functions</p>		<p>Cycle mode allows to set the number of tests to repeat and pausing time.</p> <p>Counter (number of tests to repeat): Max. 65535 times Timer (pausing time): Up to 99 min 59 sec 9 (by 0.1 sec)</p>

[Main Options]*

<p>Long stroke (-L/-2L)</p>	<p>Speed change (-V)</p>	<p>Length meter (-S)</p>
<p>This option provides extended stroke. Useful when testing stretching samples or testing for long distance.</p>	<p>This option changes the speed range. Useful for tests that require faster/slower speed condition.</p>	<p>Built in digital screen indicates travel distance of force gauge.</p>
		
<p>FA option (-FA)</p>	<p>External signal input (-CN)</p>	
<p>This option provides inbuilt linear scale. It allows displaying displacement data on force gauge together with force value and drawing FS curves in PC via USB.</p> <p>*ZTA series force gauge and optional cable are required. *Force-displacement measurement unit FSA series are also available, which includes the necessary products.</p>	<p>This option mounts the connector for external signal input. It allows inputs such as start, stop, and interlock.</p>	
		

*Available options depend on model ranges. Please refer to [Specifications] on the next page.

[Specifications]

Model	MX2-500N	MX2-1000N	MX2-2500N	MX2-5000N
Image				
Capacity	500N	1000N	2500N	5000N
Speed	Digital 10 to 300mm/min [10 - 20mm/min: by 0.5mm/min] [20 - 100mm/min: by 5mm/min] [100 - 300mm/min: by 10mm/min]			Digital 0.5 to 300mm/min [0.5 - 20mm/min: by 0.5mm/min] [20 - 100mm/min: by 5mm/min] [100 - 300mm/min: by 10mm/min]
Max. Sample Height*1	Approx. 235mm	Approx. 300mm	Approx. 320mm	Approx. 380mm
Rigidity	[Standard models] less than 0.5mm, [Long stroke (optional)] less than 1.0mm			[extended column (optional)] less than 1.0mm
Stroke Limit	Controllable with upper and lower knob			
Measuring Modes	Manual / Jog / Cycle mode			
Functions	Counter (number of tests to repeat): Max. 65535 times Timer (pausing time): Up to 99 min 59 sec 9 (by 0.1 sec)			
Control	Emergency stop, force control (*2), overload prevention (*2, *3)			
Operating temperature humidity	0 to +40 degree Celsius 35 to 70% (avoid condensation)			
Voltage	AC100 to 240V, 50/60Hz (Select from 100, 120 and 230V. Accessories are provided accordingly.)			
Power Consumption	50W			150W
Dimensions	See [Dimensions]			
Weight	Approx. 18kg	Approx. 19kg	Approx. 26kg	Approx. 51kg
Accessories	Operation manual, power cable, spare fuse, tools			Operation manual, power cable, spare fuse, tools, carrying handle, yellow cap
	GF-1 (Grip mounting adaptor)	GF-2 (Grip mounting adaptor), mounting plate for high capacity force gauge	GF-2 (Grip mounting adaptor), mounting plate for standard force gauge	
Available Options *4*5*6	-L: Extended stroke by 200mm -2L: Extended stroke by 400mm (*7) -CN: External signal input -S: Length scale -FA: Inbuilt linear scale -V45: Speed 1.5 to 45mm/min -V90: Speed 3 to 90mm/min -V450: Speed 15 to 450mm/min -V600: Speed 20 to 600mm/min -V900: Speed 30 to 900mm/min	L: Extended stroke by 300mm CN: External signal input -S: Length scale FA: Inbuilt linear scale V75: Speed 2.5 to 75mm/min V150: Speed 5 to 150mm/min V750: Speed 25 to 750mm/min V1000: Speed 35 to 1000mm/min	-L: Extended stroke by 300mm -CN: External signal input -S: Length scale -FA: Inbuilt linear scale -V75: Speed 2.5 to 75mm/min -V150: Speed 5 to 150mm/min	-EXT: Extended column by 200mm (*8) -CN: External signal input -S: Length scale -FA: Inbuilt linear scale
Mountable Force Gauge *9	Mechanical Force Gauge: FB, PS, PSM series Digital Force Gauge: DST, DSV, ZTS, ZTA series (up to 1000N) Load cell: DPU series (up to 500N *10)			
	Mechanical Force Gauge: PSH series Digital Force Gauge: ZTS, ZTA series (Over 2500N)			

- *1 Max. sample height refers to the distance between the table and the tip of force gauge measuring shaft when the head is at the top. (MX2-500N/MX2-1000N: up to 1000N model of ZTS/ZTA series, MX2-2500N/MX2-5000N: With over 2500N model of ZTS/ZTA series is mounted.)
- *2 ZTS/ZTA series force gauge and optional cable CB-528 are required.
- *3 It does not guarantee complete protection against overloading.
- *4 Add the option code after the model name to complete the model with options.
e.g. When adding long stroke option to MX2-500N ... Model: MX2-500N-L
- *5 Capacity is reduced as below by some speed change options.
MX2-500N: -V600 capacity 250N, -V900 capacity 150N MX2-1000N: -V750 capacity 500N, -V1000 capacity 250N
- *6 Amplifier such as ZTA and FA Plus2 (sold separately) or software are required to record measuring value of linear scale.
- *7 Additional charge for wooden packing (Japan domestic shipping) or LVL wooden packing (oversea shipping) are required for shipping.
- *8 The stroke does not extend. It extends the column of test stand and max. sample height is approx. 580mm.
- *9 Ensure to use within the capacity of force gauge and test stand regardless of the mountable models.
- *10 Mounting block (sold separately) is required to mount over 1000N range of DPU to MX2-1000N/MX2-2500N/MX2-5000N.

[User Mounted Unit (only for MX2-5000N)]

Length Scale : OP-MX250-S	FA version : OP-MX250-FA *1
It digitally indicates travel distance of a force gauge.	It builds a linear scale into a test stand to output travel distance of a force gauge and allows to utilize it for analysis of force-displacement relations.

- * Requires to mount the unit to current MX2-5000N by yourself.
- * Amplifier such as ZTA and FA Plus2 (sold separately) or software are required to record measuring value of linear scale.
- * Can be retrofitted to MX2-5000N-EXT (extended column option).
- *1 Select -FA option if the test stand with built in linear scale is required.

[Related Products]

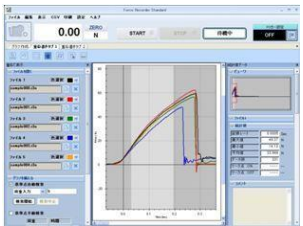
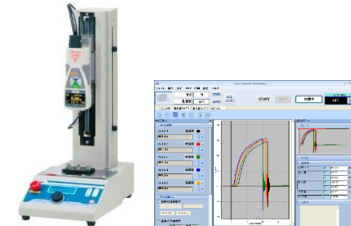



Digital Force Gauge ZTS/ZTA series	Software Force Recorder series	Force – Displacement Measurement Unit FSA series
With high sampling rate of 2000Hz, it offers highly precise measurement. Use optional cable to control motion together with MX2 series.	This graphing software can start and stop automatically based on the trigger setting of MX2 test stand function.	It draws a detailed graph of force and displacement, which is suitable for tactile test, material evaluation and more. The unit includes a force gauge, a test stand with a linear scale, a cable and a graphing software.
		
Cable	CB-528	For connecting with force gauge ZTS/ZTA series: Activates useful functions
	CB-706	For -CN option: Open end cable to connect with external device
	CB-718	For -FA option: Connects ZTA series force gauge and test stand to provide force and displacement measurement. (Motion control and related functions are also available.)

[Control Functions] Activated when ZTS/ZTA series force gauge and CB-528 are used together.

- Overload Prevention: Prevents the sensor from getting damaged due to overloading. (It does not guarantee complete protection against overloading.)
- Force control: Allows to set a force value to apply or to stop.
- Measuring speed setting: Enables automatic speed change at a point of contact using the set force value.
- Automatic measurement: Software recording and zeroing force gauge can be automatically done.

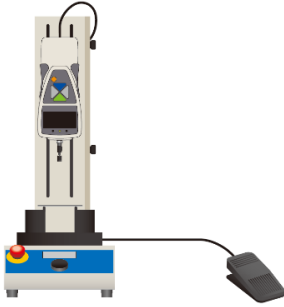
* See 'Advanced Functions of Test Stands' for details.

[Examples of Customized Solutions]

External signal input: -CN option		Interlock: -CN option	
Allows to mount a switch to start and stop operation such as a foot pedal, which improves efficiency or allows operating it together with your equipment.		Enables you to comply with a safety code by having safety shield, which stops movement of test stand when opened.	
Testing Large Samples		Controller-separated Model	
Recommended when you... - Test a sample larger than test stand table. - Test multiple points on a large sample to push in/pull.		Recommended when you... - Want to incorporate IMADA testing system into your equipment - Fix controller/drive part on a specific place - Need to prevent dangers in testing by keeping distance.	

[About MX2 series Dimensions]

Grip mounting adaptor, GF-1/GF-2, is depicted on the front view and the side view but not on the top view of MX2 series Dimensions. "M6" or "M10 (for 1000N or higher models)" on the front view and the side view are for attachment installation and "M8" on the top view indicates the position of holes for the screw to fix the grip mounting adaptor to the stand.

[MX2-500N Dimensions]

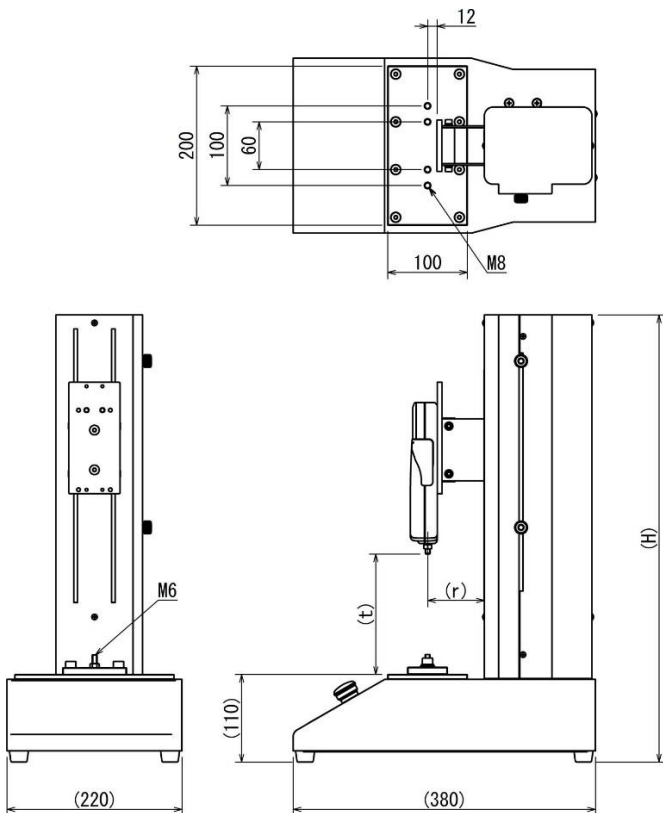

	MX2-500N	MX2-500N-L	MX2-500N-2L	
H	562	762	962	
r	With DST/DSV/ZTS/ZTA (2N to 500N) mounted			
	71			
t	With DPU (lower than 500N) mounted			
	69			
	With DST/DSV mounted	245	445	645
	With ZTS/ZTA (2N to 500N) mounted	235	435	635
	With DPU (2N to 10N) mounted	260	460	660
With DPU (20N to 500N) mounted	250	450	650	

Unit: mm

[MX2-1000N Dimensions]

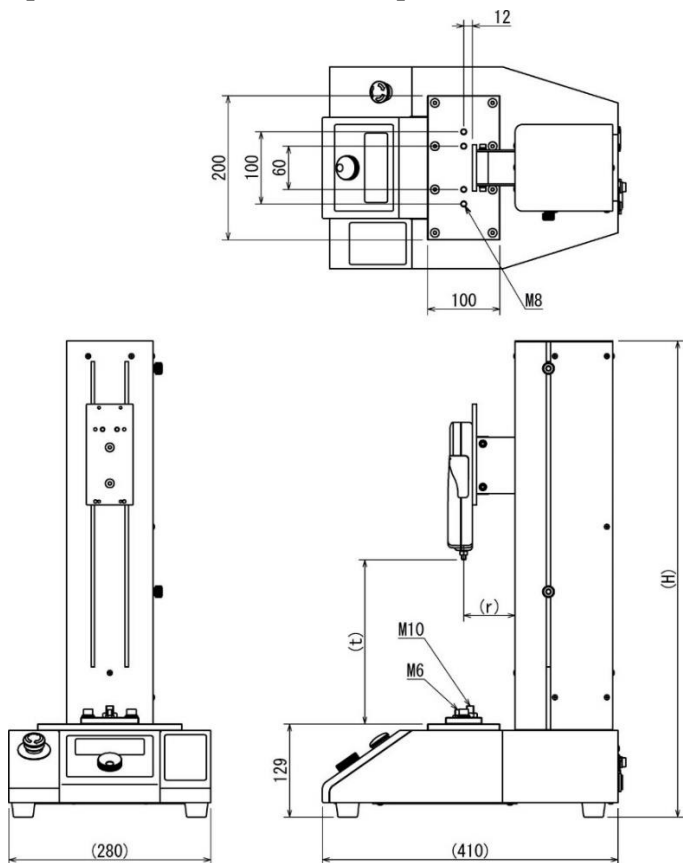

* Mounting block (sold separately) is required when mounting DPU-1000N to 5000N.

	MX2-1000N	MX2-1000N -L	
H	660	960	
r	With DST/DSV/ZTS/ZTA (2N to 1000N) mounted	71	
	With ZTS/ZTA (2500N to 5000N) mounted	74	
	With DPU (lower than 500N) mounted	69	
	With DPU (Over 1000N) mounted	73	
t	With DST/DSV mounted	310	610
	With ZTS/ZTA (2N to 1000N) mounted	300	600
	With ZTS/ZTA (2500N to 5000N) mounted	340	640
	With DPU (2N to 10N) mounted	325	625
	With DPU (20N to 500N) mounted	315	615
	With DPU (1000N to 5000N) mounted	345	645

Unit: mm

[MX2-2500N Dimensions]

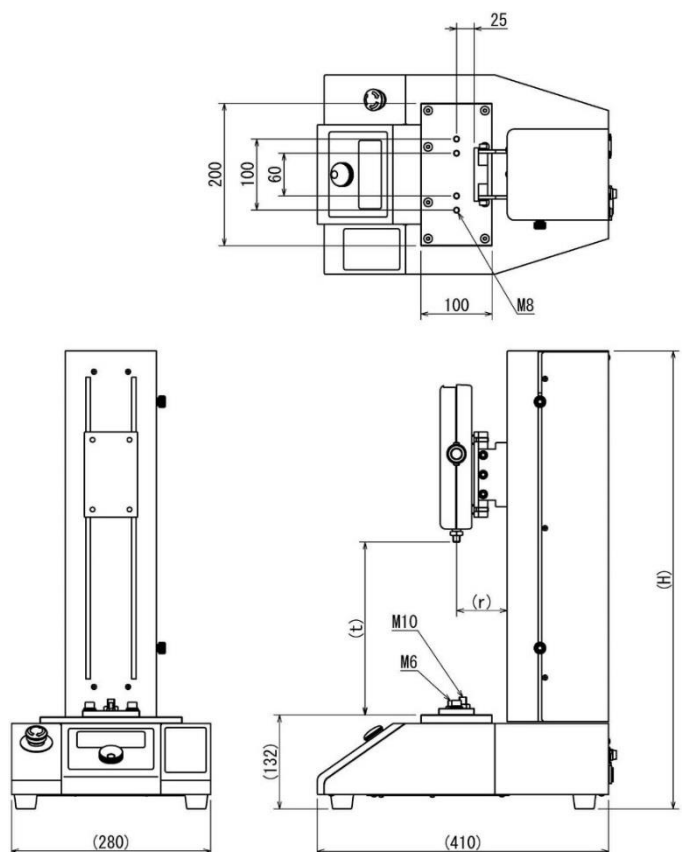

* Mounting block (sold separately) is required when mounting DPU-1000N to 5000N.

	MX2-2500N	MX2-2500N -L	
H	644	944	
r	With DST/DSV/ZTS/ZTA (2N to 1000N) mounted	72	
	With ZTS/ZTA (2500N to 5000N) mounted	71	
	With DPU (lower than 500N) mounted	70	
	With DPU (Over 1000N) mounted	74	
t	With DST/DSV mounted	320	620
	With ZTS/ZTA (2N to 1000N) mounted	315	615
	With ZTS/ZTA (2500N to 5000N) mounted	320	620
	With DPU (2N to 10N) mounted	290	590
	With DPU (20N to 500N) mounted	285	585
	With DPU (1000N to 5000N) mounted	210	510

Unit: mm

[MX2-5000N Dimensions]

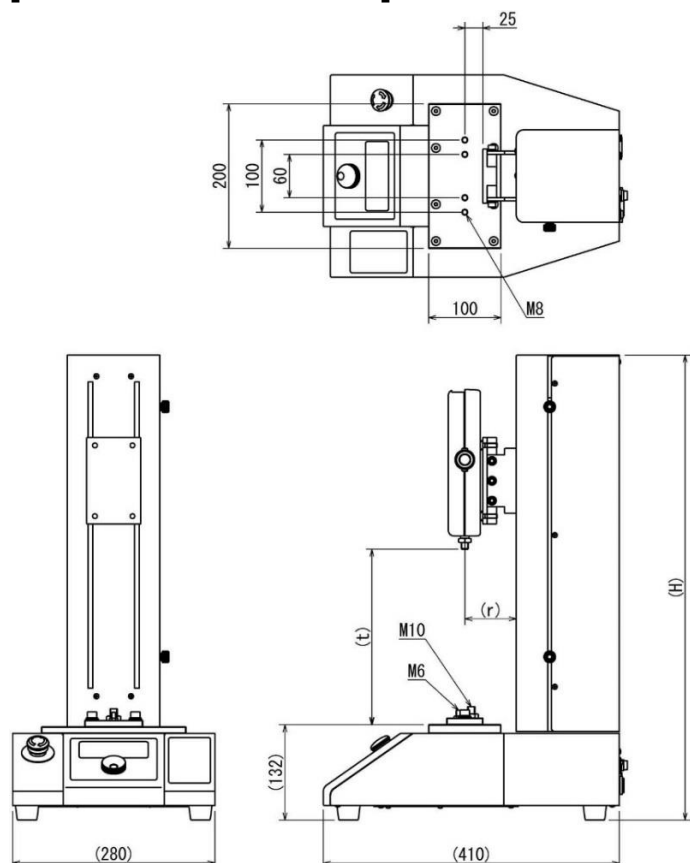

		MX2-5000N	MX2-5000N-EXT
H		823	1023
r	With ZTS/ZTA(2N to 1000N) mounted	78	
	With ZTS/ZTA (2500N to 5000N) mounted	69	
	With DPU (2N~500N) mounted	76	
	With DPU (1000N~5000N) mounted	69	
t *1	With ZTS/ZTA (2N to 1000N) mounted	88-370	288-570
	With ZTS/ZTA (2500N to 5000N) mounted	95-380	295-580
	With DPU (2N to 50N) mounted	65-350	265-550
	With DPU (100N to 500N) mounted	58-350	258-550
	With DPU (1000N to 5000N) mounted	45-335	245-535

Unit: mm

* Mounting block (sold separately) is required when mounting DPU-1000N to 5000N.

* The stroke of MX2-5000N (-EXT) has lower limit. It depends on each of force gauges and load cells.

[Cautions]

- Information in this document is subject to change without prior notice.
- This document is product descriptions and handling precautions, and do not guarantee various characteristics or safety.
- This product is designed for force measurement purpose only.
- Do not copy and use this content without authorization.
- A force gauge (sold separately) is required to use this product.
- Do not use this product in the environments including fierce temperature changes, high temperature, high humidity, near water, dusty place.

IMADA CO., LTD

99 Jinnoshinden-cho aza Kanowari Toyohashi
 Japan 441-8077
 Tel: +81-(0)532-33-3288
 Fax: +81-(0)532-33-3866
 E-mail: info@forcegauge.net
 Website: <http://www.forcegauge.net/en/>



Visit our website for more information on a wide range of product specifications, measurement applications and videos.